

Typical applications for APOS positioning systems with VAHLE conductor lines

Storage technology

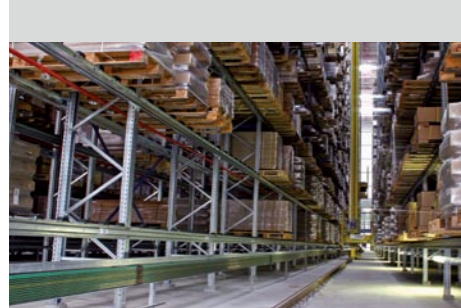

VKS 10, contactless



VKS 10, APOS in 10-pole



VKS 10, APOS in 11-pole



Crane technology

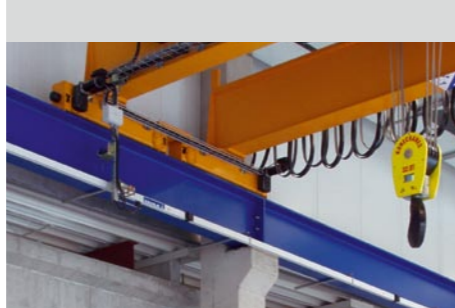

Powerail enclosed conductor system KBH



Powerail enclosed conductor system MKL



Electric monorail systems

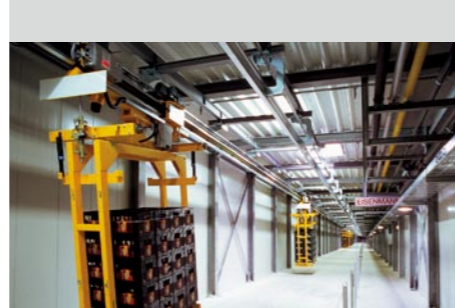

U 10 unipole insulated powerail



FABA 100 unipole insulated powerail

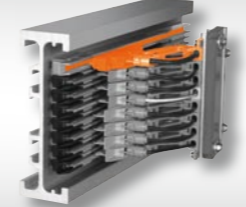

2515904/00E-2000-04/08

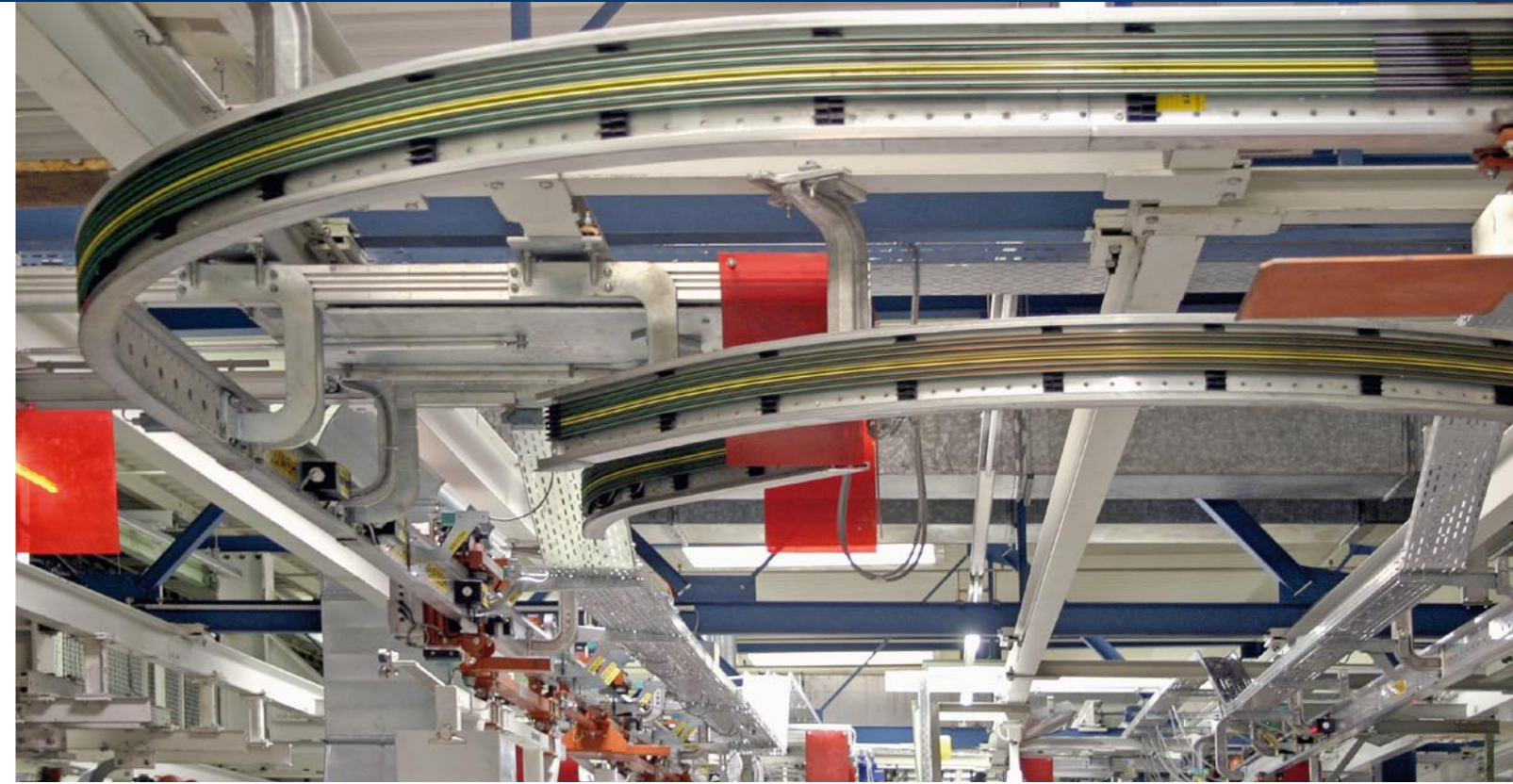

**APOS**

Positioning systems  
for VAHLE conductor lines

**SYSTEMS IN MOTION**

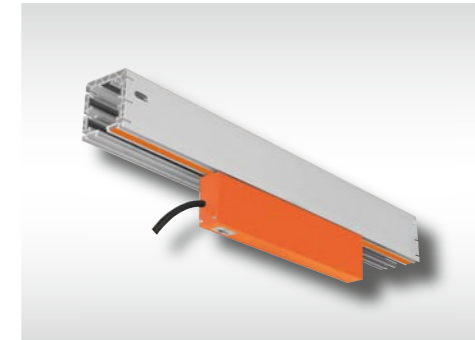

# APOS positioning systems with VAHLE conductor lines

were developed for automated handling systems in material flow technology. The control system can constantly query the absolute position of the mobile consumer.

**Operating principle**

Vahle-APOS consists of a code strip with a magnetic length coding as a reading head with integrated logic, which transmits the position to the control system via the interface. The intelligent reading head determines the position from the code strip and evaluates it for downstream control systems for processing.

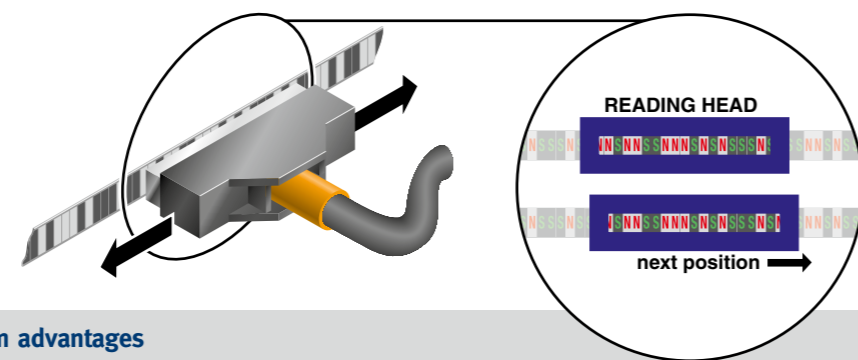

- System advantages**
- Absolute position determination up to 524 m
  - Space-saving solutions for integration into the powerail system or for installation in parallel to the runway
  - Retrofittable for U 10, FAB A 100 and VKS 10
  - Absolute position immediately available when switching on or after a power failure
  - Reliable position detection even in humid or dusty environments
  - Trouble-free functionality even in poor lighting conditions
  - Travel speed up to 5 m/s
  - The system enables the combination of horizontally and vertically combined handling equipment

## Overview of APOS components



The code strip comes factory assembled with a cross-magnetised specified code and is thus given a digital length coding.

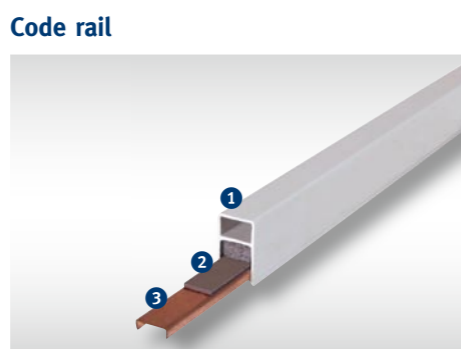

The code rail consists of the support profile (1), the code strip (2) and the sliding rail (3). The sliding rail serves for the mounting and sliding guidance of the APOS LKG-17 reading head.



Sliding scanner for powerail systems U 10, VKS 10 and FAB A 100



Contactless scanning for powerail systems VKS 10, KBH and MKL



Guide carrier for the mounting of the LB contactless reading head for KBH and MKL conductor line systems



Logging of APOS to CANopen, Profibus DP and others

## Intelligent positioning solutions with VAHLE and APOS perfectly integrated and retrofittable



Name	Type/interface	Order no.	U 10	FABA 100	KBH	MKL	VKS 10	
							contactless	sliding 10-pole 11-pole
Sliding reading head LKG-17	LKG 17 - RS 485	2823156						
	LKG 17 - RS 485 steel	2823157	●	●			●	●
	LKG 17 - SSI	2823158						
Contactless reading head LB-17	LB 17 - RS 485	2823159						
	LB 17 - RS 485 steel	2823251			●	●	●	
	LB 17 - SSI	2823252						
	LB 17 - CAN	2823253						
Interface module SB	SB - CAN	2823262	○	○				○ ○
	SB - Profibus	2823263	○	○	○	○	○	○ ○
	SB - Interbus	2823264	○	○	○	○	○	○ ○
Code band 7.5 mm	CB 75	2823254			●	●		
Code band 8 mm	CB 80	2823255	●	●				● ●
Code band 10 mm, self-adhesive	CB 100	2823256					●	
Fixing profile	FP 75	2823257			●	●		
Sliding rail 8 mm	GS 80 - 3	2823129	●	●				● ●
	TPA - U 10 - 6	2823258	●					
	TPA - FAB A 100 - 4	2806571		●				
	TPA - VKS 10/10 - 6	2823259						●
Support profile	TPA - VKS 10/11 - 6	2823265						●
	LWK	2823260			●			
	LWM	2823261				●		

● = necessary, ○ = optional